

- Meets or Exceeds the Requirement of TIA/EIA-232-F and ITU Recommendation V.28
- Withstands Sustained Output Short Circuit to Any Low-Impedance Voltage Between -25 V and 25 V
- $2\text{-}\mu\text{s}$ Maximum Transition Time Through the 3-V to -3-V Transition Region Under Full 2500-pF Load
- Inputs Compatible With Most TTL Families
- Common Strobe Input
- Inverting Output
- Slew Rate Can Be Controlled With an External Capacitor at the Output
- Standard Supply Voltages . . . $\pm 12\text{ V}$

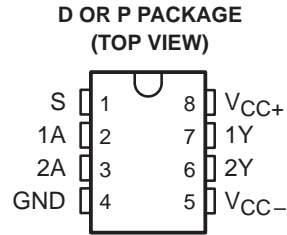

description

The SN75150 is a monolithic dual line driver designed to satisfy the requirements of the standard interface between data-terminal equipment and data-communication equipment as defined by TIA/EIA-232-F. A rate of 20 kbits/s can be transmitted with a full 2500-pF load. Other applications are in data-transmission systems using relatively short single lines, in level translators, and for driving MOS devices. The logic input is compatible with most TTL families. Operation is from 12-V and -12-V power supplies.

The SN75150 is characterized for operation from 0°C to 70°C .

logic symbol†

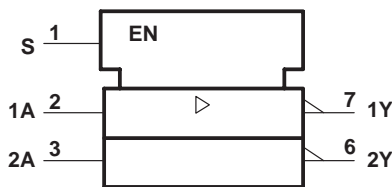

† This symbol is in accordance with ANSI/IEEE Std 91-1984 and IEC Publication 617-12.

logic diagram (positive logic)

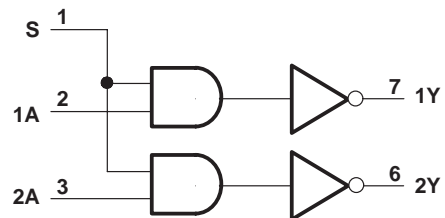

Please be aware that an important notice concerning availability, standard warranty, and use in critical applications of Texas Instruments semiconductor products and disclaimers thereto appears at the end of this data sheet.

SN75150 DUAL LINE DRIVER

SLLS081C – JANUARY 1971 – REVISED JUNE 1999

schematic (each line driver)

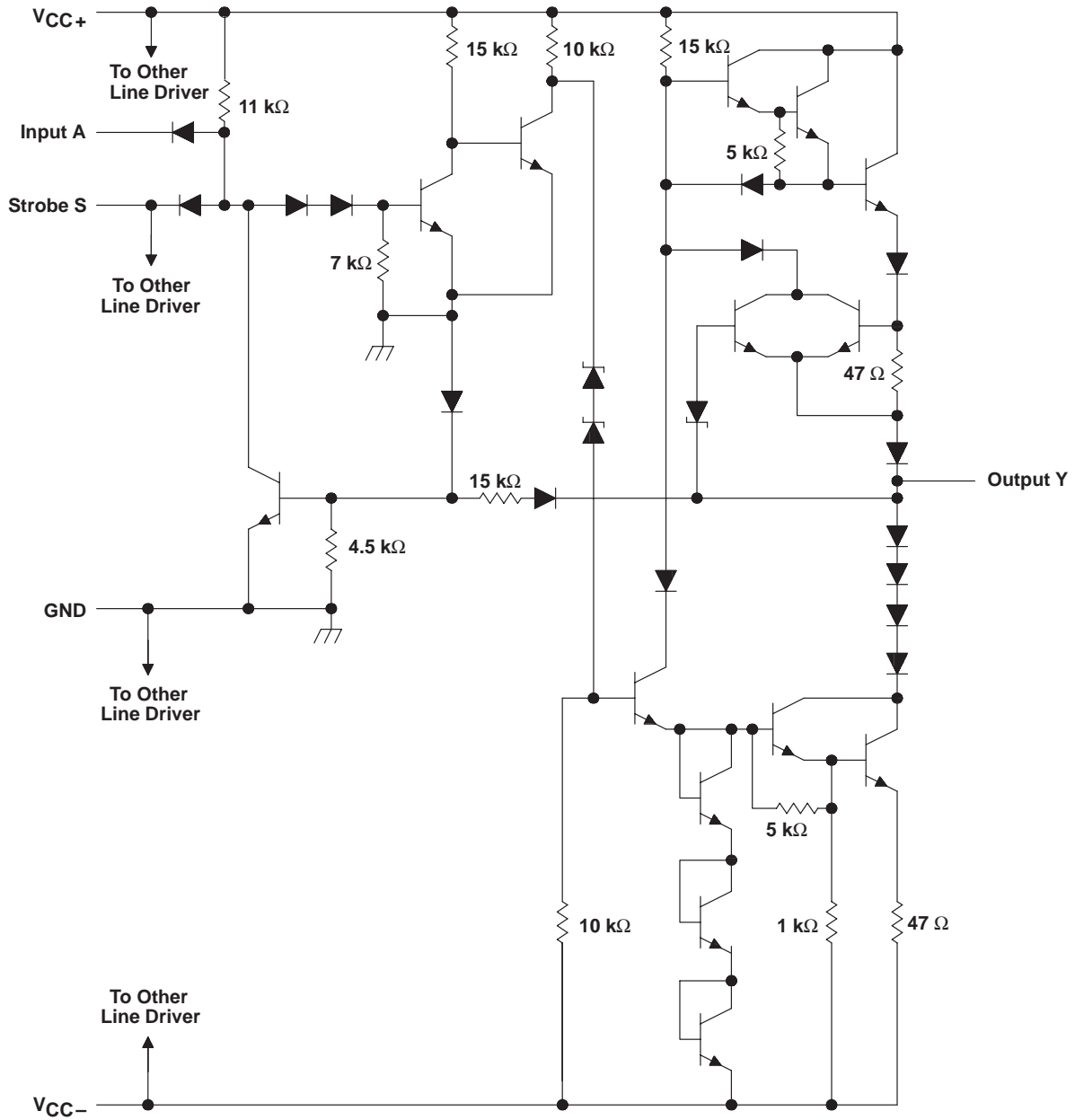

Resistor values shown are nominal.

absolute maximum ratings over operating free-air temperature range (unless otherwise noted)†

Supply voltage, V_{CC+} (see Note 1)	15 V
Supply voltage, V_{CC-}	–15 V
Input voltage, V_I	15 V
Applied output voltage	±25 V
Package thermal impedance, θ_{JA} (see Notes 2 and 3): D package	197°C/W
P package	104°C/W
Lead temperature 1,6 mm (1/16 inch) from case for 10 seconds	260°C
Storage temperature range, T_{Stg}	–65°C to 150°C

† Stresses beyond those listed under “absolute maximum ratings” may cause permanent damage to the device. These are stress ratings only, and functional operation of the device at these or any other conditions beyond those indicated under “recommended operating conditions” is not implied. Exposure to absolute-maximum-rated conditions for extended periods may affect device reliability.

- NOTES:
1. Voltage values are with respect to network ground terminal.
 2. Maximum power dissipation is a function of $T_J(\max)$, θ_{JA} , and T_A . The maximum allowable power dissipation at any allowable ambient temperature is $P_D = (T_J(\max) - T_A)/\theta_{JA}$. Operating at the absolute maximum T_J of 150°C can impact reliability.
 3. The package thermal impedance is calculated in accordance with JESD 51, except for through-hole packages, which use a trace length of zero.

recommended operating conditions

		MIN	NOM	MAX	UNIT
Supply voltage	V_{CC+}	10.8	12	13.2	V
	V_{CC-}	–10.8	–12	–13.2	
High-level input voltage, V_{IH}		2		5.5	V
Low-level input voltage, V_{IL}		0		0.8	V
Driver output voltage, V_O				±15	V
Operating free-air temperature, T_A		0		70	°C

SN75150 DUAL LINE DRIVER

SLLS081C – JANUARY 1971 – REVISED JUNE 1999

electrical characteristics over recommended operating free-air temperature range, $V_{CC\pm} = \pm 13.2\text{ V}$ (unless otherwise noted)

PARAMETER		TEST CONDITIONS	MIN	TYP†	MAX	UNIT
V_{OH}	High-level output voltage	$V_{CC+} = 10.8\text{ V}$, $V_{IL} = 0.8\text{ V}$, $V_{CC-} = -10.8\text{ V}$, $R_L = 3\text{ k}\Omega$ to $7\text{ k}\Omega$	5	8		V
V_{OL}	Low-level output voltage (see Note 4)	$V_{CC+} = 10.8\text{ V}$, $V_{IH} = 2\text{ V}$, $V_{CC-} = -10.8\text{ V}$, $R_L = 3\text{ k}\Omega$ to $7\text{ k}\Omega$		-8	-5	V
I_{IH}	High-level input current	$V_I = 2.4\text{ V}$		1	10	μA
	Data input			2	20	
I_{IL}	Low-level input current	$V_I = 0.4\text{ V}$		-1	-1.6	mA
	Strobe input			-2	-3.2	
I_{OS}	Short-circuit output current‡	$V_O = 25\text{ V}$		2	8	mA
		$V_O = -25\text{ V}$		-3	-8	
		$V_O = 0$, $V_I = 3\text{ V}$	10	15	30	
		$V_O = 0$, $V_I = 0$	-10	-15	-30	
I_{CCH+}	Supply current from V_{CC+} , high-level output	$V_I = 0$, $R_L = 3\text{ k}\Omega$, $T_A = 25^\circ\text{C}$		10	22	mA
I_{CCH-}	Supply current from V_{CC-} , high-level output			-1	-10	mA
I_{CCL+}	Supply current from V_{CC+} , low-level output	$V_I = 3\text{ V}$, $T_A = 25^\circ\text{C}$		8	17	mA
I_{CCL-}	Supply current from V_{CC-} , low-level output			-9	-20	mA

† All typical values are at $V_{CC+} = 12\text{ V}$, $V_{CC-} = -12\text{ V}$, $T_A = 25^\circ\text{C}$.

‡ Not more than one output should be shorted at a time.

NOTE 4: The algebraic convention, in which the less positive (more negative) limit is designated as minimum, is used in this data sheet for logic levels only, e.g., when -5 V is the maximum, the typical value is a more negative voltage.

switching characteristics, $V_{CC+} = 12\text{ V}$, $V_{CC-} = -12\text{ V}$, $T_A = 25^\circ\text{C}$ (see Figure 1)

PARAMETER		TEST CONDITIONS	MIN	TYP	MAX	UNIT
t_{TLH}	Transition time, low-to-high-level output	$C_L = 2500\text{ pF}$, $R_L = 3\text{ k}\Omega$ to $7\text{ k}\Omega$	0.2	1.4	2	μs
t_{THL}	Transition time, high-to-low-level output		0.2	1.5	2	μs
t_{TLH}	Transition time, low-to-high-level output	$C_L = 15\text{ pF}$, $R_L = 7\text{ k}\Omega$		40		ns
t_{THL}	Transition time, high-to-low-level output			20		ns
t_{PLH}	Propagation delay time, low-to-high-level output	$C_L = 15\text{ pF}$, $R_L = 7\text{ k}\Omega$		60		ns
t_{PHL}	Propagation delay time, high-to-low-level output			45		ns



PARAMETER MEASUREMENT INFORMATION

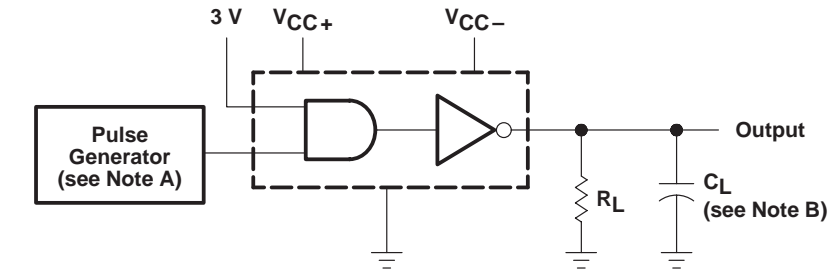

TEST CIRCUIT

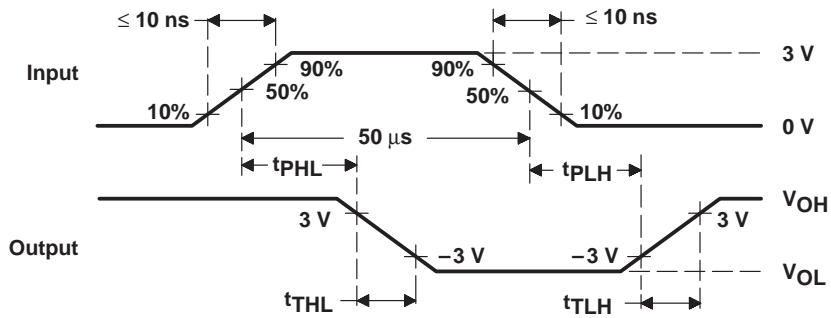

- NOTES: A. The pulse generator has the following characteristics: duty cycle $\leq 50\%$, $Z_O \approx 50 \Omega$.
B. C_L includes probe and jig capacitance.

Figure 1. Test Circuit and Voltage Waveforms

SN75150 DUAL LINE DRIVER

SLLS081C – JANUARY 1971 – REVISED JUNE 1999

TYPICAL CHARACTERISTICS

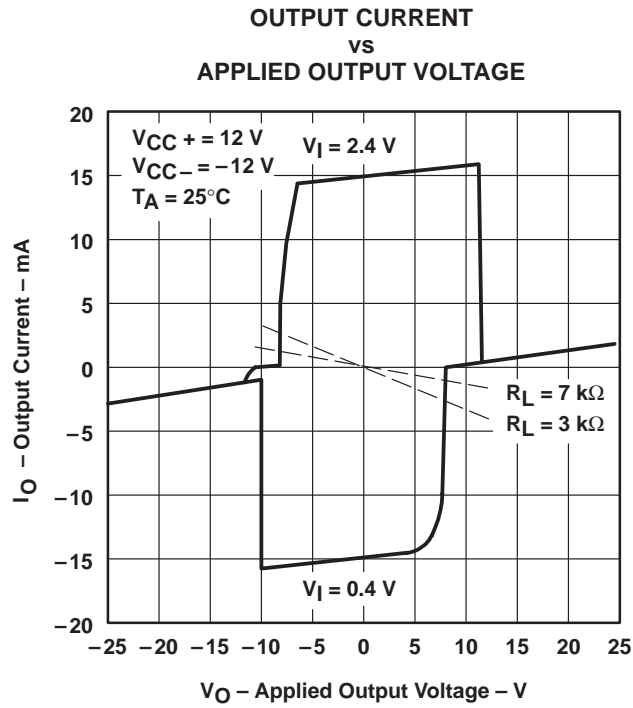

Figure 2

IMPORTANT NOTICE

Texas Instruments and its subsidiaries (TI) reserve the right to make changes to their products or to discontinue any product or service without notice, and advise customers to obtain the latest version of relevant information to verify, before placing orders, that information being relied on is current and complete. All products are sold subject to the terms and conditions of sale supplied at the time of order acknowledgement, including those pertaining to warranty, patent infringement, and limitation of liability.

TI warrants performance of its semiconductor products to the specifications applicable at the time of sale in accordance with TI's standard warranty. Testing and other quality control techniques are utilized to the extent TI deems necessary to support this warranty. Specific testing of all parameters of each device is not necessarily performed, except those mandated by government requirements.

CERTAIN APPLICATIONS USING SEMICONDUCTOR PRODUCTS MAY INVOLVE POTENTIAL RISKS OF DEATH, PERSONAL INJURY, OR SEVERE PROPERTY OR ENVIRONMENTAL DAMAGE ("CRITICAL APPLICATIONS"). TI SEMICONDUCTOR PRODUCTS ARE NOT DESIGNED, AUTHORIZED, OR WARRANTED TO BE SUITABLE FOR USE IN LIFE-SUPPORT DEVICES OR SYSTEMS OR OTHER CRITICAL APPLICATIONS. INCLUSION OF TI PRODUCTS IN SUCH APPLICATIONS IS UNDERSTOOD TO BE FULLY AT THE CUSTOMER'S RISK.

In order to minimize risks associated with the customer's applications, adequate design and operating safeguards must be provided by the customer to minimize inherent or procedural hazards.

TI assumes no liability for applications assistance or customer product design. TI does not warrant or represent that any license, either express or implied, is granted under any patent right, copyright, mask work right, or other intellectual property right of TI covering or relating to any combination, machine, or process in which such semiconductor products or services might be or are used. TI's publication of information regarding any third party's products or services does not constitute TI's approval, warranty or endorsement thereof.